

**FREE
TRAINING**

A4404 SAB
POCKET ANALYZER



1 YEAR
WARRANTY





A4404 SAB

SIGNAL ANALYZER BOX - POCKET ANALYZER

MASTER THE LANGUAGE OF YOUR MACHINERY





A4404 SAB

POCKET ANALYZER



The A4404 - SAB is a pocket sized 4 channel vibration analyzer.

Connect the A4404 - SAB to any computer by USB and use the unit for data analysing, collecting and the recording of vibration signals. The instrument is enhanced by modules for dynamic balancing, measurement of run up and coast down and acoustic measurement mode. The instrument is equipped with an expert system developed by Adash, which automatically detects machinery faults.

The instrument is powered directly by USB connection so no external power is needed.



Connect A4404 SAB to your laptop and get all functions of 4 channel analyzer VA4 Pro



Free download of VA4 Pro - Virtual Unit software enables you to try all functions of the analyzer on your computer

VA4 PRO - VIRTUAL UNIT SOFTWARE

POCKET SIZE 4 CHANNEL VIBRATION ANALYZER
Input channels: 4 AC, ICP® (ON/OFF), 4 DC, 1 TACHO



A4404 SAB MEASUREMENT MODES



ANALYZER

- › 4 channels simultaneously

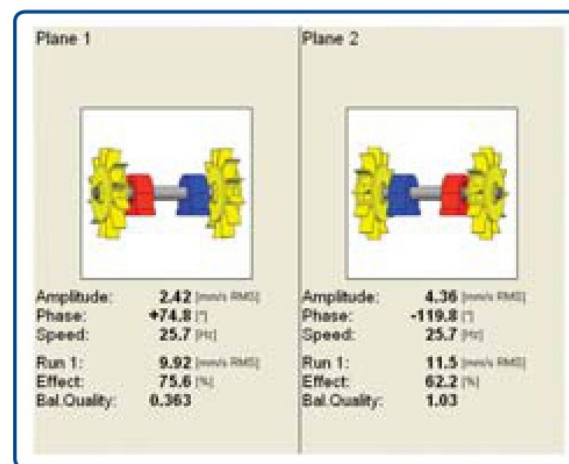

BALANCER

- › Intuitive graphical balancing procedure

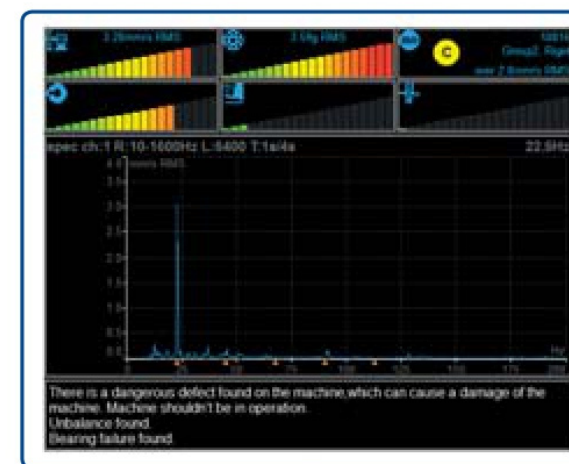

EXPERT SYSTEM

- › Automatic fault detection

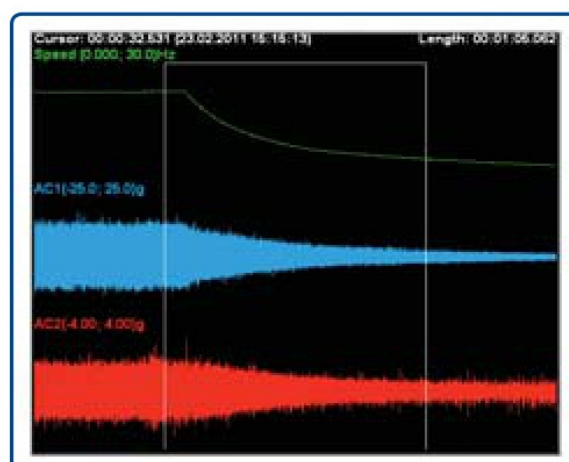

RECORDER

- › 4 channels recording
- › 35 hours signal recording



ROUTE

- › 8000 measuring points
- › DDS software

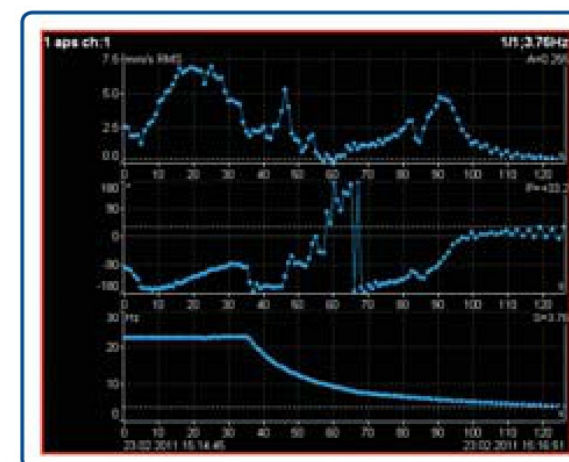

RUN UP/COAST DOWN



STETHOSCOPE

- › Listening of vibration signal

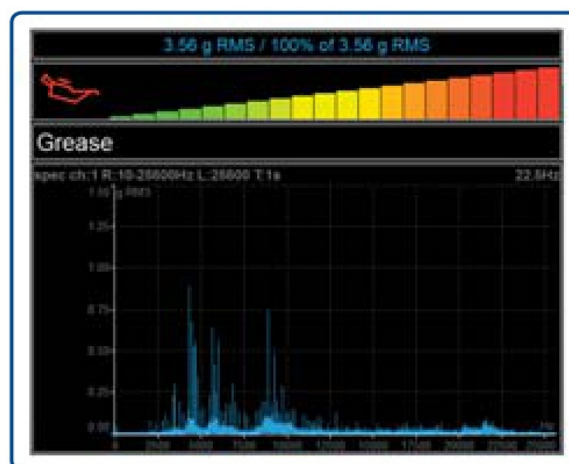

LUBRI

- › Monitoring and control of lubrication process

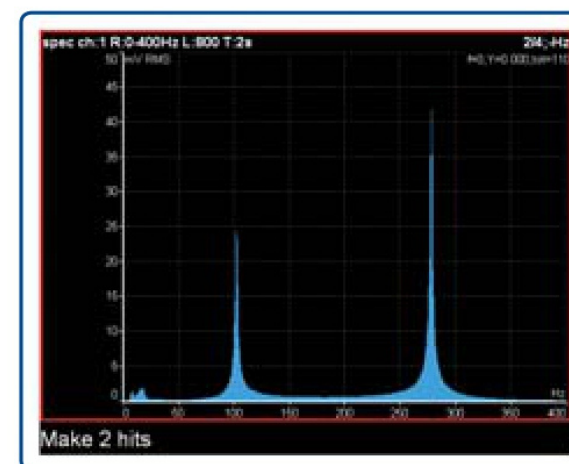

BUMP TEST

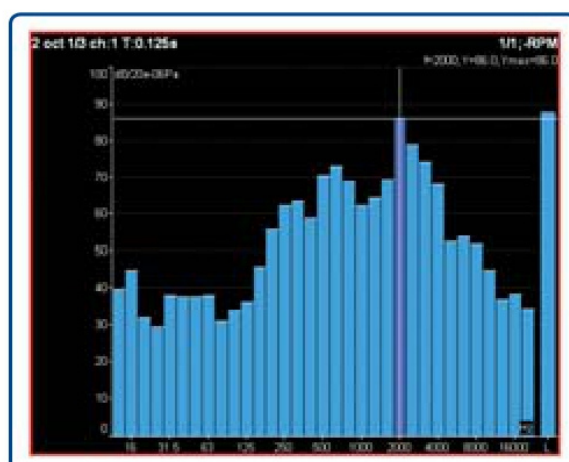

OCTAVE ANALYSIS

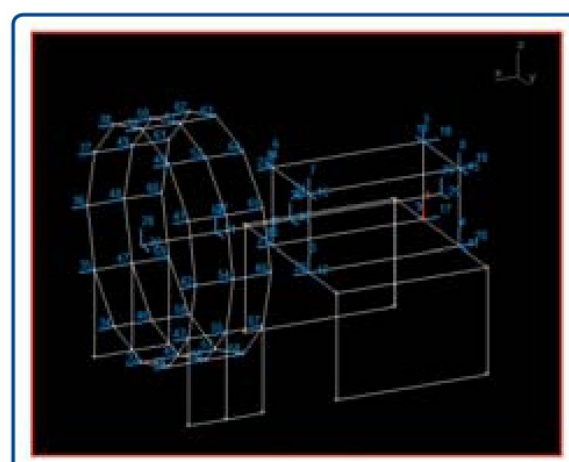

ADS

- › Animated deflection shapes

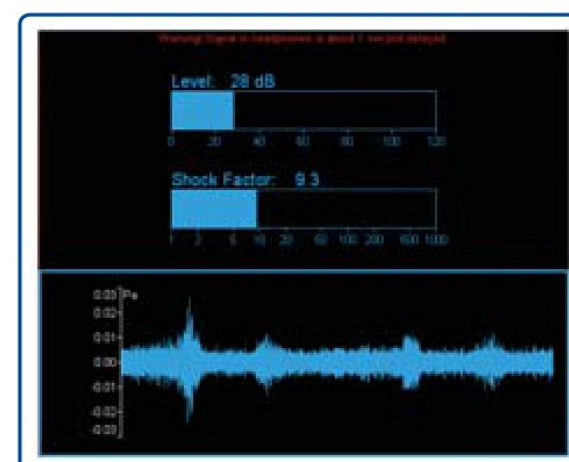

ULTRASOUND

A4404 SAB TECHNICAL SPECIFICATIONS:

Input channels:	4 AC, ICP [®] power supply on/off 4 DC for process values 1 TACHO for external trigger
Input range:	AC +/- 12 V peak-peak DC +/- 24V
AD conversion:	24 bit, 64 bit internal signal processing No AutoGain function!
Dynamic range S/N:	120 dB
Frequency ranges (-3 dB):	Maximum range: 0.35 Hz - 90 kHz (1 Ch, 194 kHz sampling) Maximum range: 0.35 Hz - 25 kHz (4 Ch, 64 kHz sampling) Minimum range: 0.35 Hz - 25 Hz (4 Ch, 64 Hz sampling)
Sampling mode:	Fully simultaneous for 4 channels
FFT resolution:	Min. 100 lines Max. 3 276 800 lines
Unit modes:	Analyzer - analytic measurement Data collector - route measurement Balancer - on-site balancing Recorder - signal recording Stethoscope FASIT - Expert system for fault detection Octave analyzer Bump test ADS - Animated Deflection Shapes Ultrasound
Processor:	According to the PC
Memory, Route:	According to the PC hard drive
Data processing:	Real time FFT DEMOD - ENVELOPE analysis ACMT - low speed bearing analysis Order analysis User band pass analysis RPM measurement DC measurement Orbit measurement
Signal recorder:	64 kHz sampling frequency 4 Ch memory consumption 3 GB/hour 4 Ch total recording - 35 hours
Trigger:	Manual, External, Signal level, Time Use for signal recording trigger Speed change, Time interval
Communication:	USB
Temperature range:	-10°C to +50°C
Power:	USB powered
Case:	Aluminium heavy duty
Size & Weight:	110 x 115 x 35 mm, 350 g

© Adash 2017